

Data Sheet – RoundAbout Cable Guide

Patent Pending

Key Features

1. Allows dynamic 3D displacement cable motion
2. Gives 360° by 317° displacement cable orientation flexibility
3. Unique curved cable guiding surface allows for dynamic displacement cable motion
4. Rugged anodized aluminum, shielded stainless steel bearings, and engineering plastics construction
5. Mountable on the position transducer or via independent mounting base
6. Reduces the need for flexible position transducer mounting bases
7. Saves time: no need to re-locate or re-orient the position transducer after installation

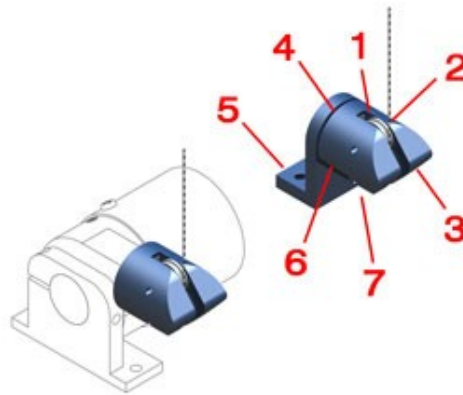

Specifications

Parameter	Value
Materials	anodized aluminum, stainless steel, engineering plastics
Displacement Cable Compatibility	0.018–inch (0.46–mm) dia. optimum, up to 0.027–inch (0.69–mm) dia. possible with reduced lifetime
Mechanical Life	40 million linear cable inches min estimated using 0.018–inch (0.46–mm) dia. cable
Operating Temperature	–85° to +257° F (–65° to +125° C)
Shock, Vibration	100 g for 6 ms, 10 to 2000 Hz at 15 g
Nominal Mass	2 oz (60 g)
Environmental Protection	NEMA 3S / IP 44

Part Numbers

Part Number	Description
300224	cable guide: RoundAbout, standalone
300225	cable guide: RoundAbout, with mounting base
301202	mounting base: RoundAbout

The RoundAbout cable guide may also be ordered already installed on [Series 16_](#) and [Series 6](#) position transducers. The RoundAbout cable guide cannot be installed by the user to existing position transducers.

Application Examples

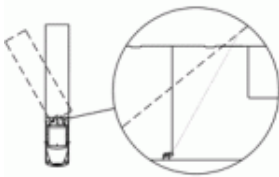

5th wheel and trailer hitch tracking



simulator control

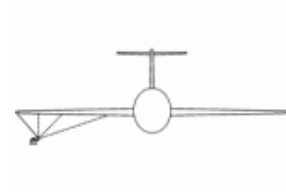

aircraft ground testing

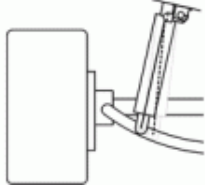

automotive suspension monitoring

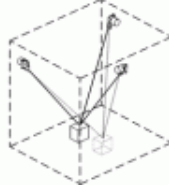

local GPS systems

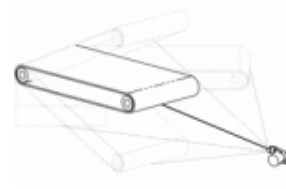

material handling

Drawing

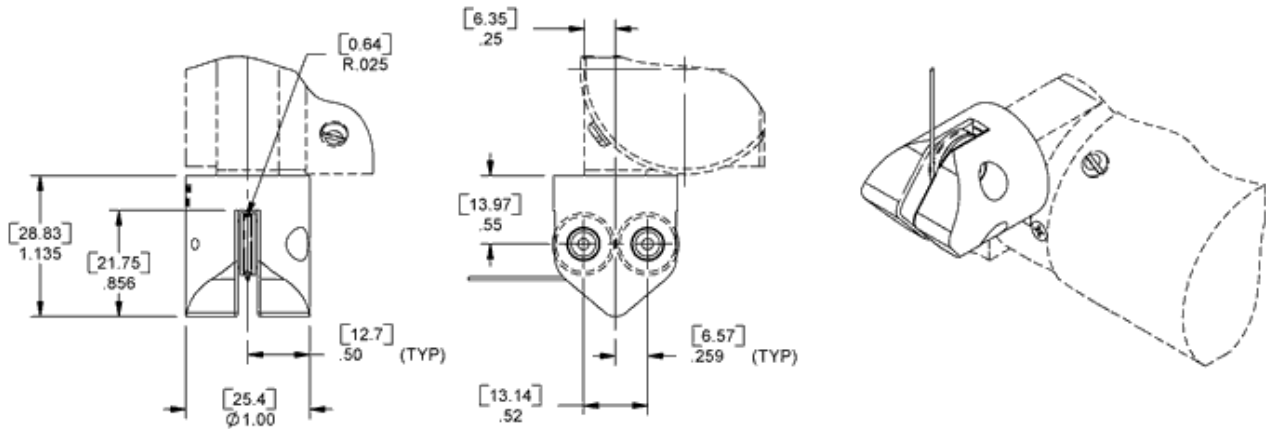

RoundAbout cable guide mounted to position transducers (pn 301224)

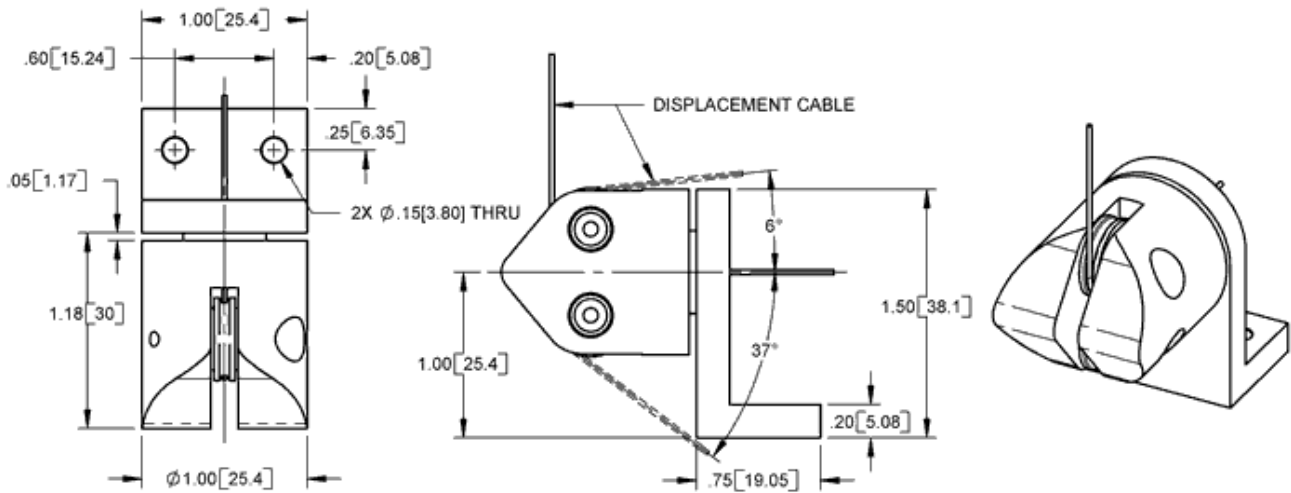

RoundAbout cable guide with mounting base; displacement cable angular flexibility: 360° continuous by +174° -143° (pn 301225)

Patent Pending

For crimping of hardware to displacement cable, consider the [160001-01 installation kit](#).

Need something not shown? Complete a [Custom Solution Request](#).

All dimensions are REFERENCE and are in inches [mm] • Document number: S021S(041026)